



BaYoPal®: Technical data



8279.130 

| | |
|---------------------|-------------------|
| Ext. (mm) | 1200 x 1000 x 165 |
| Weight (Kg) | 23.8 |
| Stacked height (mm) | 165 |
| Static load (Kg) | 6000 |
| Dynamic load (Kg) | 1500 |
| Racking load (Kg) | 1200 |

Ventilated smooth deck - 3 skids - no rim



8279.110 

| | |
|---------------------|-------------------|
| Ext. (mm) | 1200 x 1000 x 170 |
| Weight (Kg) | 23.9 |
| Stacked height (mm) | 165 |
| Static load (Kg) | 6000 |
| Dynamic load (Kg) | 1500 |
| Racking load (Kg) | 1200 |

Ventilated smooth deck - 3 skids - 5mm rim

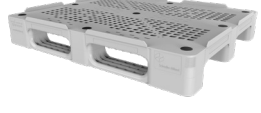

8279.120 

| | |
|---------------------|-------------------|
| Ext. (mm) | 1206 x 1006 x 187 |
| Weight (Kg) | 24.0 |
| Stacked height (mm) | 165 |
| Static load (Kg) | 6000 |
| Dynamic load (Kg) | 1500 |
| Racking load (Kg) | 1200 |

Ventilated smooth deck - 3 skids - 22mm rim

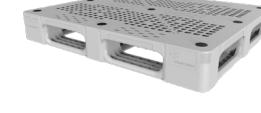

8279.230 

| | |
|---------------------|-------------------|
| Ext. (mm) | 1200 x 1000 x 165 |
| Weight (Kg) | 23.9 |
| Stacked height (mm) | 165 |
| Static load (Kg) | 6000 |
| Dynamic load (Kg) | 1500 |
| Racking load (Kg) | 1200 |

Ventilated smooth deck - 5 skids - no rim



8279.210 

| | |
|---------------------|-------------------|
| Ext. (mm) | 1200 x 1000 x 170 |
| Weight (Kg) | 24.0 |
| Stacked height (mm) | 165 |
| Static load (Kg) | 6000 |
| Dynamic load (Kg) | 1500 |
| Racking load (Kg) | 1200 |

Ventilated smooth deck - 5 skids - 5mm rim



8279.220 

| | |
|---------------------|-------------------|
| Ext. (mm) | 1206 x 1006 x 187 |
| Weight (Kg) | 24.1 |
| Stacked height (mm) | 165 |
| Static load (Kg) | 6000 |
| Dynamic load (Kg) | 1500 |
| Racking load (Kg) | 1200 |

Ventilated smooth deck - 5 skids - 22mm rim



8279.330 

| | |
|---------------------|-------------------|
| Ext. (mm) | 1200 x 1000 x 165 |
| Weight (Kg) | 24.2 |
| Stacked height (mm) | 165 |
| Static load (Kg) | 6000 |
| Dynamic load (Kg) | 1500 |
| Racking load (Kg) | 1200 |

Ventilated smooth deck - 6 skids - no rim

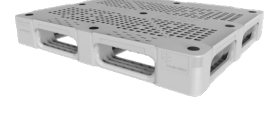

8279.310 

| | |
|---------------------|-------------------|
| Ext. (mm) | 1200 x 1000 x 170 |
| Weight (Kg) | 24.3 |
| Stacked height (mm) | 165 |
| Static load (Kg) | 6000 |
| Dynamic load (Kg) | 1500 |
| Racking load (Kg) | 1200 |

Ventilated smooth deck - 6 skids - 5mm rim

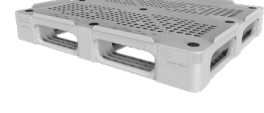

8279.320 

| | |
|---------------------|-------------------|
| Ext. (mm) | 1206 x 1006 x 187 |
| Weight (Kg) | 24.4 |
| Stacked height (mm) | 165 |
| Static load (Kg) | 6000 |
| Dynamic load (Kg) | 1500 |
| Racking load (Kg) | 1200 |

Ventilated smooth deck - 6 skids - 22mm rim

Contact us for antislip option and top deck plugs option.

360°

Schoeller Allibert Returnable Plastic Packaging Solutions

 BaYoPal®

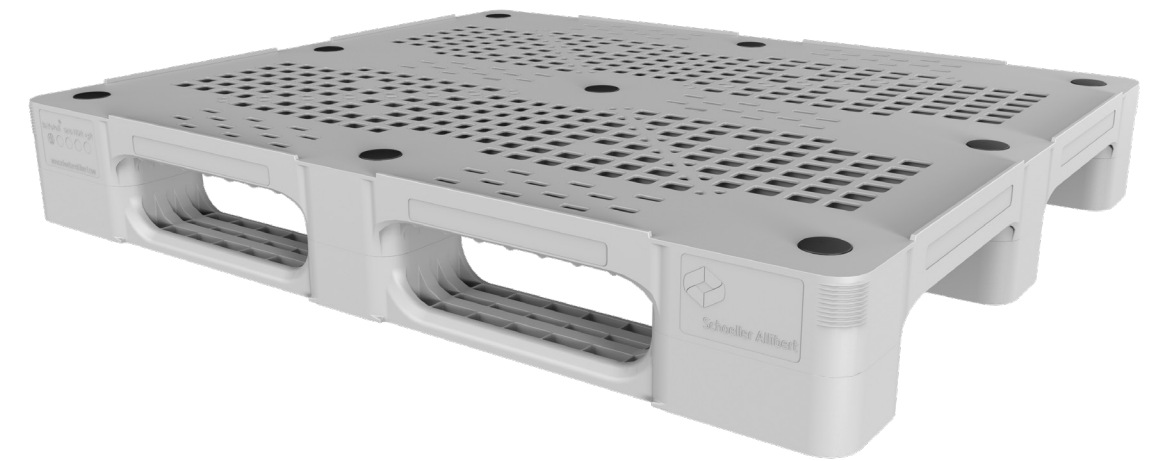

In line with its policy of continuous development, Schoeller Allibert reserve the right to amend product specifications described in this catalogue without prior notice. Most of products are protected by patent, registered design or copyright. Texts, characteristics, pictures and plans are not contractual. Design and production by MAGINA - Creation 10/2019



Schoeller Allibert
Innovating your logistics for a better world



Please visit our website
www.schoellerallibert.com



Schoeller Allibert
Innovating your logistics for a better world

BaYoPal®: hard to break - easy to repair the new Schoeller Allibert pallet

The new base of durable profitable and efficient logistics

Outstanding performances

Very sturdy the BaYoPal® equipped with three five or six runners, takes up to 6000kg static load, 1500kg dynamic load and 1200kg on racks. Compatible with most pallets on the market it's a perfect solution for pooling activity.

Ideal for internal and external logistics

The BaYoPal® pallet works seamlessly on all robotized handling systems. Silent on conveyors thanks to its runners base design, it is also available with 7 mm or 22 mm top rim to adapt to all intralogistics and loading/unloading devices.

Optional anti slip feature on the top deck and on fork entries for even more safety of loads during transportation and handling operation. A 1500 kg unit load also ensures optimised truck loads, for and efficient outbound logistics.

Unique unrivalled repairability and life span

Repairs are fast easy and low cost: the unique patented bayonet connection between the top deck and the runners, ensures that shocks and potential misuse with pallet jacks will not damage either the runners or the deck, only the bayonet weak ring will break.

BaYoPal® is sustainable: the pallet lasts longer, the maintenance and repair costs are kept low and at the end of its service life it is 100 % recyclable.

Standard and safe

Compliant to the utmost pallet standards and norms, BaYoPal® performances are tested according to (ISO8611), guaranteeing safety of loads and operators.

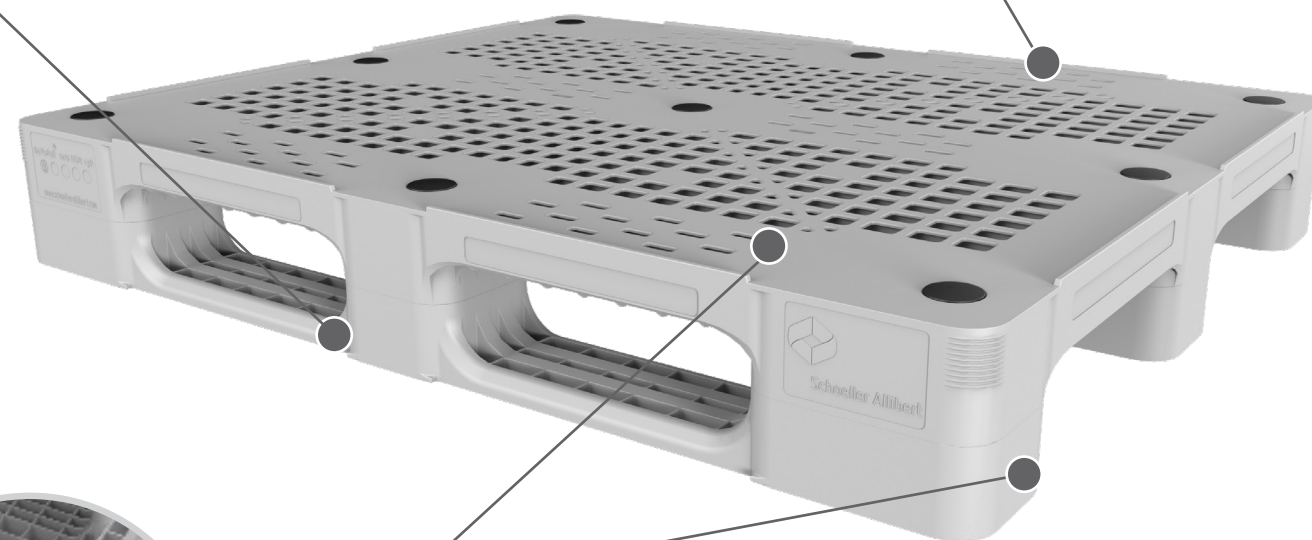

The Industrial manufacturing and e-business pooling pallet

Designed for harsh applications: reinforced corner structure and perforated top deck with a rib- web structure for maximised rigidity without metal reinforcement. Available in multiple variants to match all industrial sectors logistics needs: Smooth top deck to welcome cardboard boxes, with a 5 mm high top rim to hold any kind of plastic containers, and a 22mm high top rim version to hold empty upside down Euro containers.

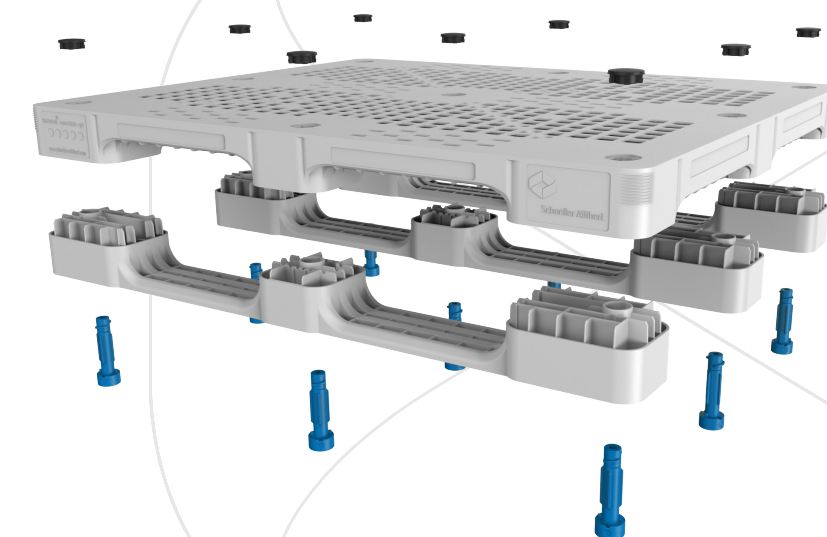

BaYoPal®
the versatile wide range
for all logistics applications

3, 5 or 6 runners, smooth deck
or 5 mm top rim or 22 mm top rim.

Customisation and tracking

BaYoPal® features locations for RFID tags and IOT beacons to ensure efficient tracking on demand.

To facilitate fleet management, guarantee your property and enhance your brand awareness, large marking or engraving zones are located on all feet.